

K package: 1200V 800A IGBT module

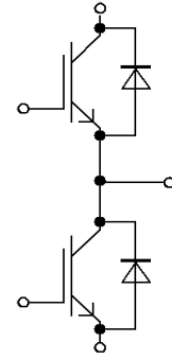

Equivalent Circuit Schematic

### Features:

- 1200V 800A,  $V_{CE(sat)} = 1.50V @ 25^{\circ}C$
- Trench/FS Technology
- Low Losses
- High RBSOA capability
- Low reverse-recovery losses

### 产品特性:

- 1200V 800A,  $V_{CE(sat)} = 1.50V @ 25^{\circ}C$
- 沟槽栅/场终止技术
- 低损耗
- 高 RBSOA 能力
- 低反向恢复损耗

### Typical Applications:

- High Power Converters
- Motor Drives
- Uninterrupted Power Supply
- Photovoltaic

### 典型应用:

- 大功率变频器
- 电机传动
- 不间断电源
- 光伏

## IGBT, Inverter / IGBT , 逆变部分

### Maximum Rated Values / 最大标称参数

Collector-emitter Voltage 集电极-发射极电压	$T_{vj}=25^{\circ}\text{C}$	$V_{CES}$	1200	V
Continuous DC collector current 集电极连续直流电流		$I_{C\text{ nom}}$	800	A
	$T_C=80^{\circ}\text{C}, T_{vj\text{ max}}=175^{\circ}\text{C}$	$I_C$	875	A
Repetitive Peak collector current 集电极可重复峰值电流	$I_{CRM}=2 \times I_{C\text{ nom}}$	$I_{CRM}$	1600	A
Total power dissipation 总功率损耗	$T_C=25^{\circ}\text{C}, T_{vj\text{ max}}=175^{\circ}\text{C}$	$P_{\text{tot}}$	3060	W
Gate-emitter peak voltage 门极-发射极峰值电压		$V_{GES}$	$\pm 20$	V

### Characteristic Values / 性能参数

			min.	typ.	max.		
Collector-emitter saturation Voltage 集电极-发射极饱和压降	$I_C=800\text{A}, V_{GE}=15\text{V}$	$T_{vj}=25^{\circ}\text{C}$	$V_{CE\text{ sat}}$	1.50	1.70	V	
	$I_C=800\text{A}, V_{GE}=15\text{V}$	$T_{vj}=125^{\circ}\text{C}$		1.75			
	$I_C=800\text{A}, V_{GE}=15\text{V}$	$T_{vj}=150^{\circ}\text{C}$		1.77			
	$I_C=800\text{A}, V_{GE}=15\text{V}$	$T_{vj}=175^{\circ}\text{C}$		1.79			
Gate Threshold Voltage 门极阈值电压	$V_{CE}=V_{GE}, I_C=16\text{mA},$	$T_{vj}=25^{\circ}\text{C}$	$V_{GE\text{ th}}$	5.0	6.0	7.0	V
Gate Charge 门极电荷	$V_{GE} = -15\text{ V} \dots +15\text{ V}$		$Q_G$	tbd			$\mu\text{C}$
Internal Gate Resistor 内置门极电阻	$T_{vj}=25^{\circ}\text{C}$		$R_{G\text{ int}}$	0.32			$\Omega$
Input Capacitance 输入电容	$V_{CE} = 25\text{V}, V_{GE} = 0\text{V}$ $f = 1\text{MHz}$		$C_{\text{ies}}$	tbd			nF
Reverse Transfer Capacitance 反向传输电容			$C_{\text{res}}$	tbd			nF
Collector-emitter Cutoff Current 集电极-发射极关断漏电流	$V_{CE}=1200\text{V}, V_{GE}=0\text{V},$	$T_{vj}=25^{\circ}\text{C}$	$I_{CES}$		200		$\mu\text{A}$
Gate-emitter Leakage Current 门极-发射极漏电流	$V_{CE}=0\text{V}, V_{GE}=\pm 20\text{V},$	$T_{vj}=25^{\circ}\text{C}$	$I_{GES}$		$\pm 100$		nA
Turn-on Delay Time, Inductive Load 开通延迟时间, 感性负载	$I_C=800\text{A}, V_{CE}=600\text{V}$ $V_{GE}= 15\text{V}/-8\text{V}$ $R_{G\text{ on}}=0.5\Omega$	$T_{vj}=25^{\circ}\text{C}$	$t_{\text{don}}$	270		ns	
		$T_{vj}=125^{\circ}\text{C}$		280			
		$T_{vj}=150^{\circ}\text{C}$		280			
		$T_{vj}=175^{\circ}\text{C}$		285			
Rise Time, Inductive Load 上升时间, 感性负载	$I_C=800\text{A}, V_{CE}=600\text{V}$ $V_{GE}= 15\text{V}/-8\text{V}$ $R_{G\text{ on}}=0.5\Omega$	$T_{vj}=25^{\circ}\text{C}$	$t_r$	100		ns	
		$T_{vj}=125^{\circ}\text{C}$		110			
		$T_{vj}=150^{\circ}\text{C}$		110			
		$T_{vj}=175^{\circ}\text{C}$		115			
Turn-off Delay Time, Inductive Load 关断延迟时间, 感性负载	$I_C=800\text{A}, V_{CE}=600\text{V}$ $V_{GE}= 15\text{V}/-8\text{V}$ $R_{G\text{ off}}=5.6\Omega$	$T_{vj}=25^{\circ}\text{C}$	$t_{\text{doff}}$	1420		ns	
		$T_{vj}=125^{\circ}\text{C}$		1490			
		$T_{vj}=150^{\circ}\text{C}$		1510			
		$T_{vj}=175^{\circ}\text{C}$		1540			
Fall Time, Inductive Load 下降时间, 感性负载	$I_C=800\text{A}, V_{CE}=600\text{V}$ $V_{GE}= 15\text{V}/-8\text{V}$ $R_{G\text{ off}}=5.6\Omega$	$T_{vj}=25^{\circ}\text{C}$	$t_f$	120		ns	
		$T_{vj}=125^{\circ}\text{C}$		125			
		$T_{vj}=150^{\circ}\text{C}$		140			
		$T_{vj}=175^{\circ}\text{C}$		150			

Turn-on energy loss per pulse 开通损耗	$I_C=800A, V_{CE}=600V$ $L_{\sigma}=28nH, V_{GE}=15V/-8V$ $R_{Gon}=0.5\Omega, di/dt =$ $5600 A/\mu s (T_{vj}=175^{\circ}C)$	$T_{vj}=25^{\circ}C$ $T_{vj}=125^{\circ}C$ $T_{vj}=150^{\circ}C$ $T_{vj}=175^{\circ}C$	$E_{on}$		48.0 70.0 78.0 85.0		mJ
Turn-off energy loss per pulse 关断损耗	$I_C=800A, V_{CE}=600V$ $L_{\sigma}=28nH, R_{Goff}=5.6\Omega$ $V_{GE}=15V/-8V, dv/dt =$ $4000 V/\mu s (T_{vj}=175^{\circ}C)$	$T_{vj}=25^{\circ}C$ $T_{vj}=125^{\circ}C$ $T_{vj}=150^{\circ}C$ $T_{vj}=175^{\circ}C$	$E_{off}$		117.0 138.0 142.0 153.0		mJ
SC Data 短路耐量	$V_{CE}=600V, V_{GE}=15V/-8V,$ $T_{vj}=150^{\circ}C$		$t_{psc}$	8			$\mu s$
Thermal Resistance, Junction to Case 结-壳热阻	Per IGBT/单个 IGBT		$R_{thJC}$		0.049		K/W
Temperature under switching conditions 工作温度			$T_{vj op}$	-40		150	$^{\circ}C$

### Diode, Inverter / 二极管, 逆变部分

#### Maximum Rated Values / 最大标称参数

Repetitive peak reverse voltage 可重复反向峰值电压	$T_{vj}=25^{\circ}C$	$V_{RRM}$	1200	V
Continuous DC Forward Current 可连续正向直流电流		$I_F$	800	A
Repetitive Peak Forward Current 可重复正向峰值电流	$I_{CRM}=2 \times I_{Fnom}$	$I_{FRM}$	1600	A

#### Characteristic Values / 性能参数

			min.	typ.	max.	
Forward Voltage 正向通态压降	$I_F=800A, V_{GE}=0V$ $I_F=800A, V_{GE}=0V$ $I_F=800A, V_{GE}=0V$ $I_F=800A, V_{GE}=0V$	$T_{vj}=25^{\circ}C$ $T_{vj}=125^{\circ}C$ $T_{vj}=150^{\circ}C$ $T_{vj}=175^{\circ}C$	$V_F$	2.10 2.05 2.05 1.90	2.60	V
Peak Reverse Recovery Current 反向恢复峰值电流	$I_F=800A, V_R=600V$ $-di_F/dt=4800A/\mu s, (T_{vj}=175^{\circ}C)$ $V_{GE}=-8V$	$T_{vj}=25^{\circ}C$ $T_{vj}=125^{\circ}C$ $T_{vj}=150^{\circ}C$ $T_{vj}=175^{\circ}C$	$I_{RM}$	340 415 445 465		A
Recovery Charge 反向恢复电荷	$I_F=800A, V_R=600V$ $-di_F/dt=4800A/\mu s, (T_{vj}=175^{\circ}C)$ $V_{GE}=-8V$	$T_{vj}=25^{\circ}C$ $T_{vj}=125^{\circ}C$ $T_{vj}=150^{\circ}C$ $T_{vj}=175^{\circ}C$	$Q_R$	30.5 57.0 65.0 75.0		$\mu C$
Reverse Recovery Energy 反向恢复损耗	$I_F=800A, V_R=600V$ $-di_F/dt=4800A/\mu s, (T_{vj}=175^{\circ}C)$ $V_{GE}=-8V$	$T_{vj}=25^{\circ}C$ $T_{vj}=125^{\circ}C$ $T_{vj}=150^{\circ}C$ $T_{vj}=175^{\circ}C$	$E_{rec}$	14.0 27.0 33.0 40.0		mJ
Thermal Resistance, Junction to Case 结-壳热阻	Per Diode / 单个 Diode		$R_{thJC}$	0.082		K/W
Temperature under switching conditions 工作温度			$T_{vj op}$	-40		150 $^{\circ}C$

**Module / 模块**

Isolation Test Voltage 绝缘测试电压	RMS, f=50Hz, t=1min	$V_{ISOL}$	3.0	KV
Material of Module Baseplate 模块底板材料			Cu	
Internal Isolation 内部绝缘	基本绝缘 (class 1, IEC 61140) Basic insulation (class1,IEC 61140)		$Al_2O_3$	
Creepage Distance 爬电距离	端子-散热片 terminal to heatsink 端子-端子 terminal to terminal		29.0 23.0	mm
Clearance 电气间隙	端子-散热片 terminal to heatsink 端子-端子 terminal to terminal		23.0 11.0	mm
Comparative Tracking Index 相对漏电起痕指数		CTI	>400	

				min.	typ.	max.	
Stray Inductance Module 模块杂散电感		$L_{sCE}$		20			nH
Module Lead Resistance, Terminals-Chip 模块引脚电阻, 端子-芯片	$T_C = 25^\circ C$ , 每个开关 per switch	$R_{CC+EE}$		0.70			m $\Omega$
Storage Temperature 贮存温度		$T_{stg}$	-40		125		$^\circ C$
Modul Mounting torque 模块安装扭距	M6	M	3.0		6.0		Nm
Terminal Mounting torque 端子安装扭距	M6	M	2.5		5.0		Nm
Weight 重量		G		320			g

- 1) Terminal impedance is not included.  
不包含端子阻抗。

输出特性 IGBT, 逆变器(典型值)

Output characteristic IGBT Inverter (typical)

$I_C = f(V_{CE})$ ,

$V_{GE} = 15V$

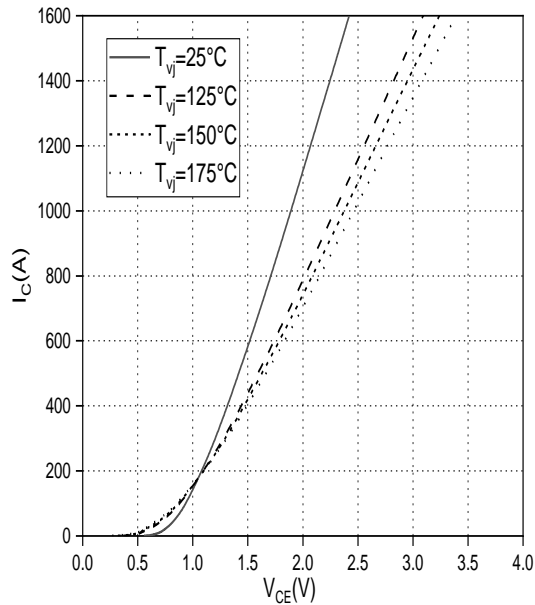

输出特性 IGBT, 逆变器(典型值)

output characteristic IGBT Inverter (typical)

$I_C = f(V_{CE})$ ,

$T_{vj} = 175^\circ C$

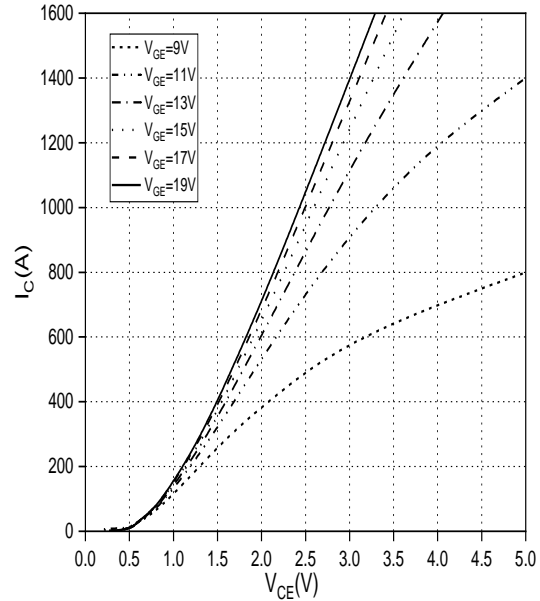

传输特性 IGBT, 逆变器 (典型值)

Transfer characteristic IGBT, Inverter (typical)

$I_C = f(V_{GE})$ ,

$V_{CE} = 20V$

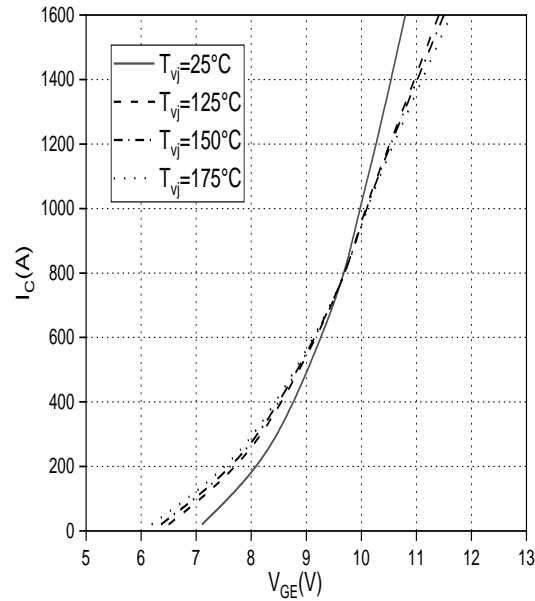

开关损耗 IGBT, 逆变器 (典型值)

switching losses IGBT, Inverter (typical)

$E_{on} = f(I_C), E_{off} = f(I_C), V_{GE} = 15V/-8V$ ,

$R_{Gon} = 0.5\Omega, R_{Goff} = 5.6\Omega, V_{CE} = 600V$

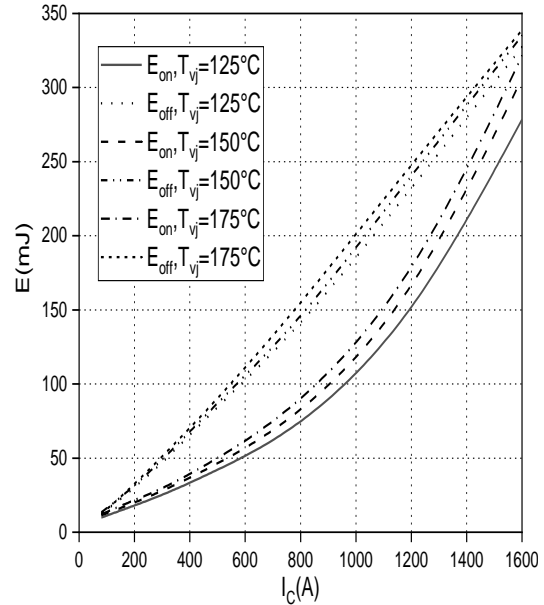

开关损耗 IGBT, 逆变器 (典型值)  
Switching losses IGBT, Inverter (typical)  
 $V_{GE} = 15V/-8V, I_C = 800A, V_{CE} = 600V$

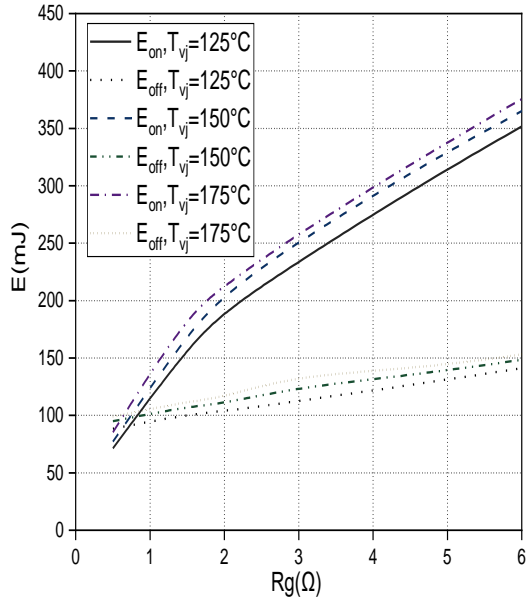

瞬态热阻抗 IGBT, 逆变器  
transient thermal impedance IGBT, Inverter  
 $Z_{thJC} = f(t)$

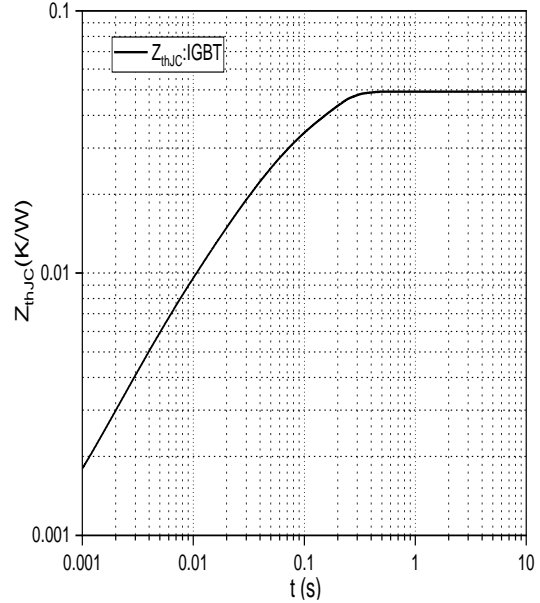

反偏安全工作区 IGBT, 逆变器 (RBSOA)  
Reverse bias safe operating area IGBT, Inverter (RBSOA)  $I_C = f(V_{CE})$ ,  
 $V_{GE} = 15V/-8V, R_{Goff} = 5.6\Omega, T_{vj} = 175^\circ C$

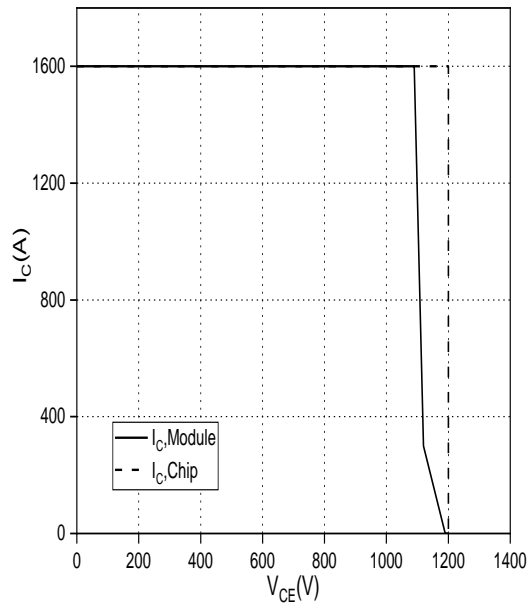

正向偏压特性二极管, 逆变器 (典型值)  
forward characteristic of Diode, Inverter (typical)  
 $I_F = f(V_F)$

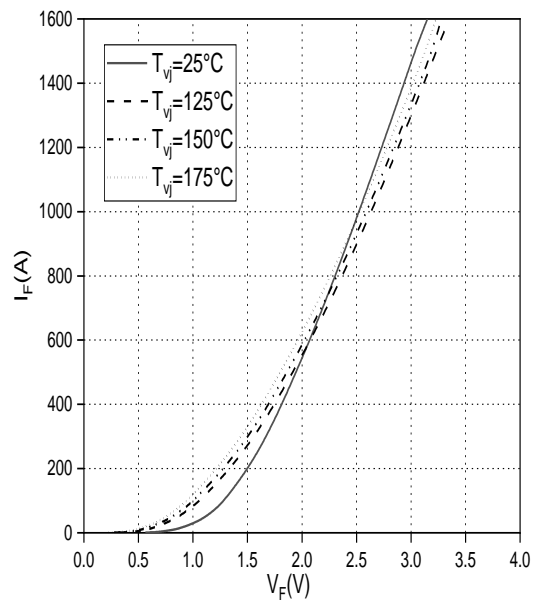

开关损耗二极管,逆变器 (典型值)  
 Switching losses Diode, Inverter (typical)  
 $E_{rec} = f(I_F)$   
 $R_{Gon} = 0.5\Omega, V_{CE} = 600V$

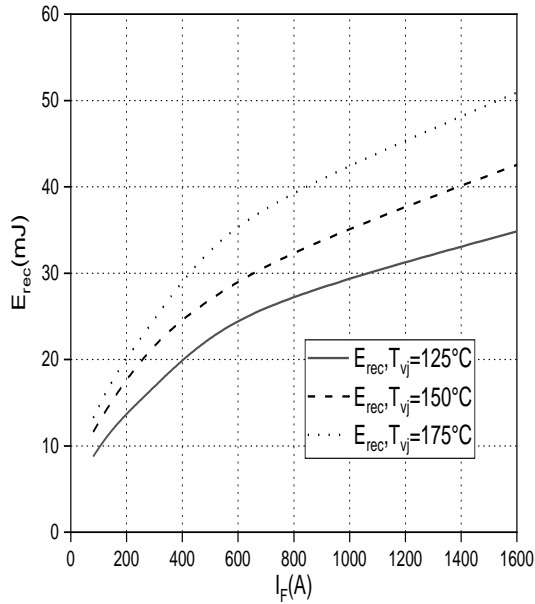

开关损耗二极管,逆变器 (典型值)  
 switching losses Diode, Inverter (typical)  
 $E_{rec} = f(R_G)$   
 $I_F = 800A, V_{CE} = 600V$

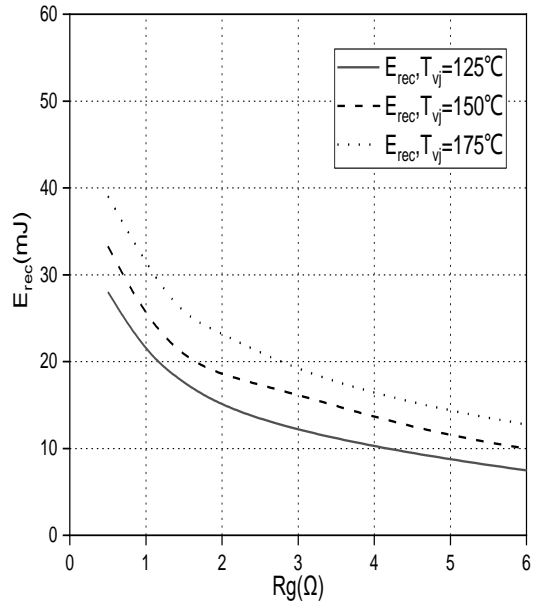

瞬态热阻抗二极管,逆变器  
 transient thermal impedance Diode, Inverter  
 $Z_{thJC} = f(t)$

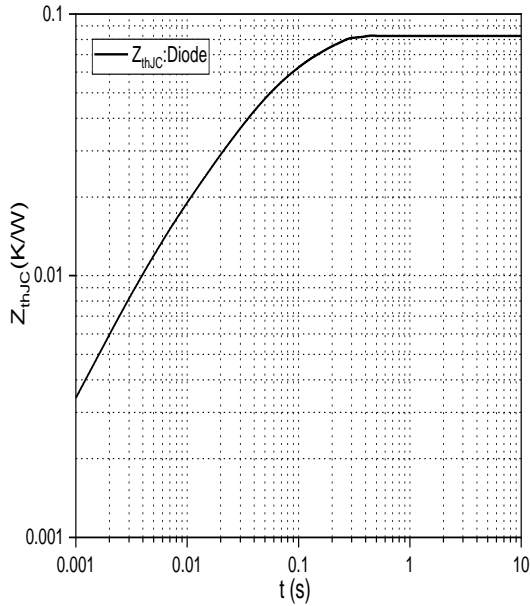

**Internal Circuit:**

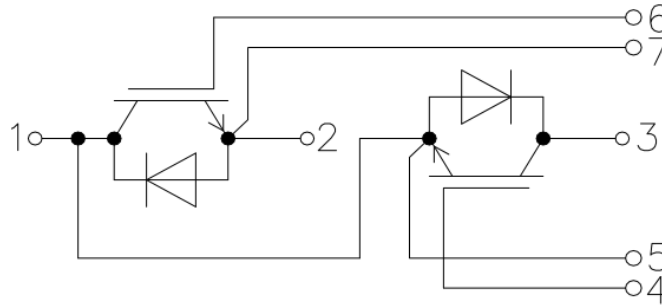

**Package Dimension  
Dimensions in Millimeters**

